

# SUMMER CHALLENGE

## 2021



## Get ready to Level Up & Power Up Your Robot!

Where else can you  
earn great prizes just  
for having a blast  
this summer?

Check out Summer Challenge, the cool, free summer program that lets kids have fun while learning! And did we mention prizes?

Just go to [LVCCLD.org/SummerChallenge](http://LVCCLD.org/SummerChallenge) to learn more and to access our awesome online resources. All you need is a free library card. Don't have one? Easy! Just sign up for our new eCard at [LVCCLD.org/eCard](http://LVCCLD.org/eCard).

## Keep Kids Engaged This Summer!

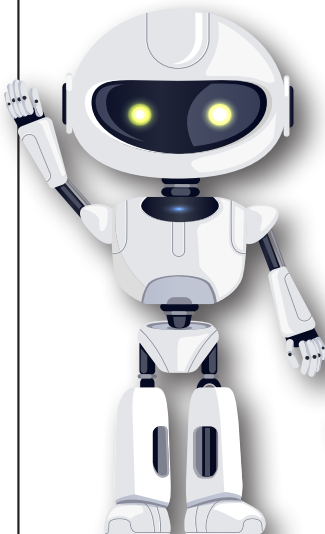

Reading, science, art, math, and critical thinking skills can slide for kids and teens during summer break. Make summer fun and fascinating for every age by entering your kids in the library's free Summer Challenge program. They can earn prizes by reading what they like and doing fun learning activities.

## TWO WAYS TO TRACK YOUR PROGRESS



**Online on Beanstack:**

Go to [LVCCLD.org/SummerChallenge](http://LVCCLD.org/SummerChallenge)



Use the paper log included in this packet.

# SUGGESTED FUN LEARNING ACTIVITIES

This is just a sample of the activities you can do this summer.

## Babies, Toddlers & Preschoolers (Ages 0-5)

- Sing a nursery rhyme and get up and dance with your family.
- Attend a storytime or have one at home!
- Pick up a Take & Make at your local branch and do it at home.
- Create a musical instrument out of household items.
- Enjoy an outdoor picnic with family.
- Build a fort or tent and then cozy up with a book.

SCAN TO FIND OUT MORE!



## Elementary (Grades K-5)

- Go for a walk and see how many bird species you can find.
- Make your own marble run with household materials.
- Read a fairytale and draw your favorite character.
- Play a board or card game with your family.
- Paint rocks and hide them around for people to find.
- Learn a magic trick and teach or show it to others.
- Go outside and look up at the night sky; try to identify a constellation.

SCAN TO FIND OUT MORE!



## Tweens & Teens (Grades 6-12)

- Draw a small comic starring you and your friends.
- Bake a cake or dessert and deliver it to your friend's house.
- Cook a new recipe with your family.
- Plant a seed and grow it into a healthy plant.
- Create a podcast.
- Do a tabletop roleplay game with your friends or family (like Dungeons & Dragons).
- Make a zine to share with your friends.

SCAN TO FIND OUT MORE!



## AND EARN

# AWESOME PRIZES!



### Book Prizes

Earn a book after completing each level. Books are available for pick-up at your local library.

### Power Up Grand Prizes

Complete all three levels, and earn a chance to win prizes valued at \$50. Prizes vary by library location. Please check with your library for more information. To find the location nearest you, please go to [LVCCLD.org/Locations](http://LVCCLD.org/Locations).

### Super Reader 900-Volt Challenge Prizes

Take your reading to the next level and you will earn a chance to win a limited edition Library District #GetCarded Tote Bag filled with a Vegas Golden Knights "Chance" Plush Toy, a Las Vegas Lights FC Anytime Ticket Book & Souvenir Scarf, an iPad Mini, and more!



# Ongoing Programs & Activities at the Library

Check back to these QR codes often to see the most up-to-date programs, schedules, and locations.



**STORYTIMES**



**TODDLER FUN**



**TAKE & MAKE KITS FOR ALL AGES**



**THREE SQUARE MEAL DISTRIBUTION FOR CHILDREN AGES 0-18**



**STEAM & MAKER PROGRAMS**



**4-H PROGRAMS**



**PUPPET SHOWS**



**ARTS & CRAFTS PROGRAMS FOR ALL AGES**



**PRESCHOOL FUN**







# HEY PARENTS!

## Keep your child's education on track

- Looking for solutions this summer? The Library District has the answer with our FREE Summer Challenge program, where kids of all ages can win great prizes while sharpening their school skills!
- Kids & Teens each get age-customized activities and fun reading options for every ability. Record their reading & activities on the attached paper log or go to [LVCCLD.org/SummerChallenge](http://LVCCLD.org/SummerChallenge) and follow the link to Beanstack.
- Babies through Age 5 can play, too, with your participation! We have a special Summer Challenge program that gives little ones a head start by reading, singing, dancing, talking, playing, and writing together! Pick up the special Summer Challenge log for Ages 0-5 at your local library branch or print a copy at [LVCCLD.org/SummerChallenge](http://LVCCLD.org/SummerChallenge) in the Parents (Children Under 5) section.



### Partners in Parenting Workshops May-July

UNR Extension offers many educational programs, workshops, and resources for parents with young children. Ages 3-5.



### Molly of Denali Workshops June-July

In these Vegas PBS workshops, grownups learn how to support children through the exploration of family and community. Ages 5-8.



### Yogapalooza with Bari Koral June 4-5

Try yoga with a dancing bear or help create a giant roller coaster of kids. Ages 3-8.



### Jim Gill July 21-24

Listen to energetic rhythms on banjo while everyone claps, jumps, and dances along. Ages 3-8.



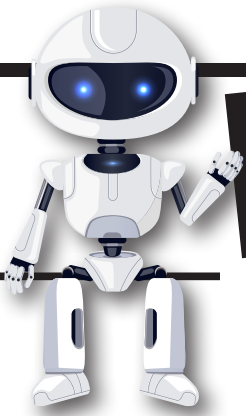

**HEY KIDS!**

## Summer is twice as fun ...

when you can earn prizes doing fun things at the library.



**Adam London**  
**May-July**

Magician Adam London will amaze you at this family-friendly magic show. Ages 5-17.



**Doktor Kaboom**  
**June 7-9**

Check out a series of spectacular, and often successful, demonstrations of the physical sciences, with a focus on the scientific method. Ages 8-17.



**Kuniko Yamamoto**  
**June 16-18**

Charming Japanese folktales are combined with traditional musical instruments, magical masks, origami, and mime to create a spellbinding story. Ages 3-17.



**Pirate School:**  
**Follow YOUR Compass**  
**July 29-31**

This interactive comedy-adventure show by David Engel aims to liberate kids from the fear of bullies, while promoting empathy and social courage. Ages 5-11.



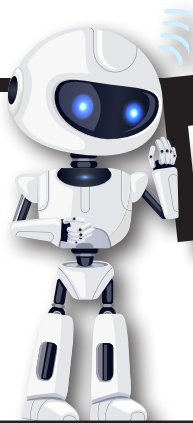

# HEY TEENS!

## Learn new skills & have a blast ...

when you check out our DJ lab, video production, podcasting, and more.



### Anime Your Way July 12-17

This drawing program by former Simpson's artist Carlos Nieto III teaches you how to create an anime character from scratch, no matter what your drawing level is! Grades 6-12.



### Teen Tech

Interactive, hands-on experiences in 3-D printing, podcasting, DJing, music producing, and more! Grades 6-12.



### Photography & Photoshop

Take photos and learn about lighting, camera operation, and editing. Grades 6-12.



### Gaming

Play a wide range of leisure and competitive games with other teens. Grades 6-12.





# #LibrariesDoThat

Check Us Out Online!

Did you know that you can learn a new language, develop your artistic skills, and download free music at LVCCCLD.org? Our website offers a world of discovery from the comfort of your home.

## Creativebug



Over 1,000 free video classes on painting, knitting, crafting, sewing, and more!

Visit LVCCCLD.org or scan the QR code for details.



## Freemal



Download and keep six songs a week and stream three hours of music per day.

Visit LVCCCLD.org or scan the QR code for details.



## Rosetta Stone & Transparent Language



Online lessons to build reading, writing, speaking, and listening skills in 30 languages.

Visit LVCCCLD.org or scan the QR code for details.



## IXL



Offers K-12 students unlimited practice in over 6,000 topics and adapts the learning experience so they can work at their own pace.

Visit LVCCCLD.org or scan the QR code for details.

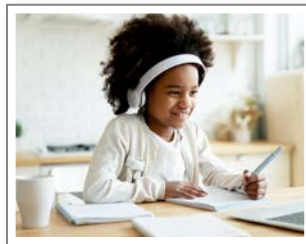

## Brainfuse



Live, online homework help is available for students daily from 1 p.m. to 10 p.m.

Visit LVCCCLD.org or scan the QR code for details.



## #GetCarded @ LVCCCLD.org

To access all of our cool online resources, all you need is a free library card. Don't have one? Easy! Just sign up for our new eCard at LVCCCLD.org/eCard. PLUS you can stream and download eBooks, audiobooks, movies, music, and more.

# Library Locations



Blue Diamond Library  
16A Cottonwood Dr., 89004  
702.875.4295

Bunkerville Library  
150 W. Virgin St., 89007  
702.346.5238

Centennial Hills Library  
6711 N. Buffalo Dr., 89131  
702.507.6114

Clark County Library  
1401 E. Flamingo Rd., 89119  
702.507.3436

East Las Vegas Library  
2851 E. Bonanza Rd., 89101  
702.507.3517

Enterprise Library  
8310 S. Las Vegas Blvd., 89123  
702.507.3760

Goodsprings Library  
365 W. San Pedro Ave., 89019  
702.874.1366

Indian Springs Library  
715 Gretta Ln., 89018  
702.879.3845

Laughlin Library  
2840 S. Needles Hwy., 89029  
702.507.4060

Meadows Library  
251 W. Boston Ave., 89102  
702.474.0023

Mesquite Library Campus  
160 W. First North St., 89027  
702.346.5224

Moapa Town Library  
1340 E. Hwy. 168, 89025  
702.864.2438

Moapa Valley Library  
350 N. Moapa Valley Blvd., 89040  
702.397.2690

Mt. Charleston Library  
75 Ski Chalet Pl., 89124  
702.872.5585

Rainbow Library  
3150 N. Buffalo Dr., 89128  
702.507.3712

Sahara West Library  
9600 W. Sahara Ave., 89117  
702.507.3644

Sandy Valley Library  
650 Quartz Ave., 89019  
702.723.5333

Searchlight Library  
200 Michael Wendell Way, 89046  
702.297.1442

Spring Valley Library  
4280 S. Jones Blvd., 89103  
702.507.3823

Summerlin Library  
1771 Inner Circle Dr., 89134  
702.507.3865

Sunrise Library  
5400 Harris Ave., 89110  
702.507.3905

West Charleston Library  
6301 W. Charleston Blvd., 89146  
702.507.3947

West Las Vegas Library  
951 W. Lake Mead Blvd., 89106  
702.507.3983

Whitney Library  
5175 E. Tropicana Ave., 89122  
702.507.4015

Windmill Library  
7060 W. Windmill Ln., 89113  
702.507.6041

## Thank You to Our Community Partners

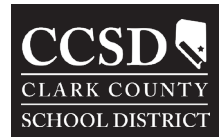

EXTENSION  
College of Agriculture,  
Biotechnology & Natural Resources



# POWER UP YOUR ROBOT

KIDS & TEENS

## SUMMER CHALLENGE LOG

May 15–July 31, 2021

### HERE'S HOW:

- Name your robot.
- Power up your robot with fun learning & reading activities at each level.
- Color in the shapes:  = 30 Minutes of Reading  = Fun Learning Activity
- Return your log to the library after each level and collect a book prize.
- Complete all three levels & turn in your log for a chance to win a prize worth \$50.
- Are you a super reader? Take the optional 900-Volt Challenge while completing your Power Up reading and learning activities!

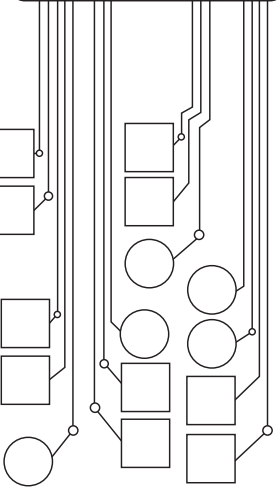
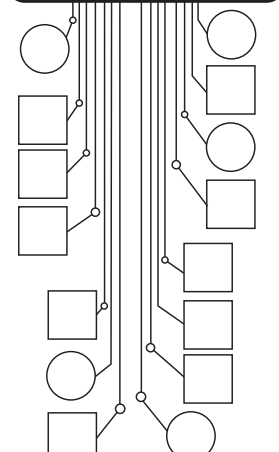
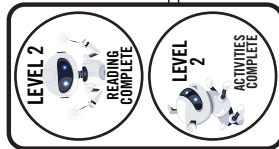
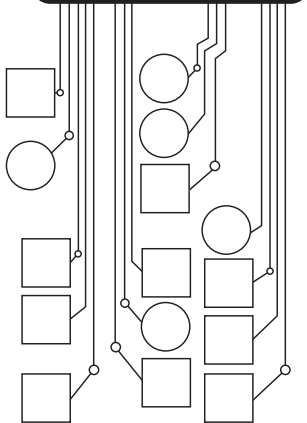
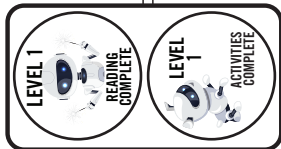
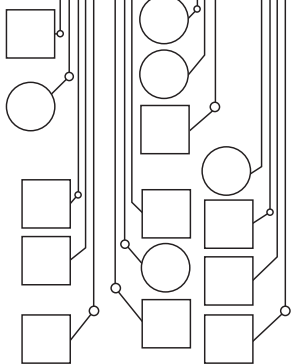

### LEVEL 1

Complete this level between  
May 15 – July 31.

### LEVEL 2

Complete this level between  
June 1 – July 31.

### LEVEL 3

Complete this level between  
July 1 – July 31.

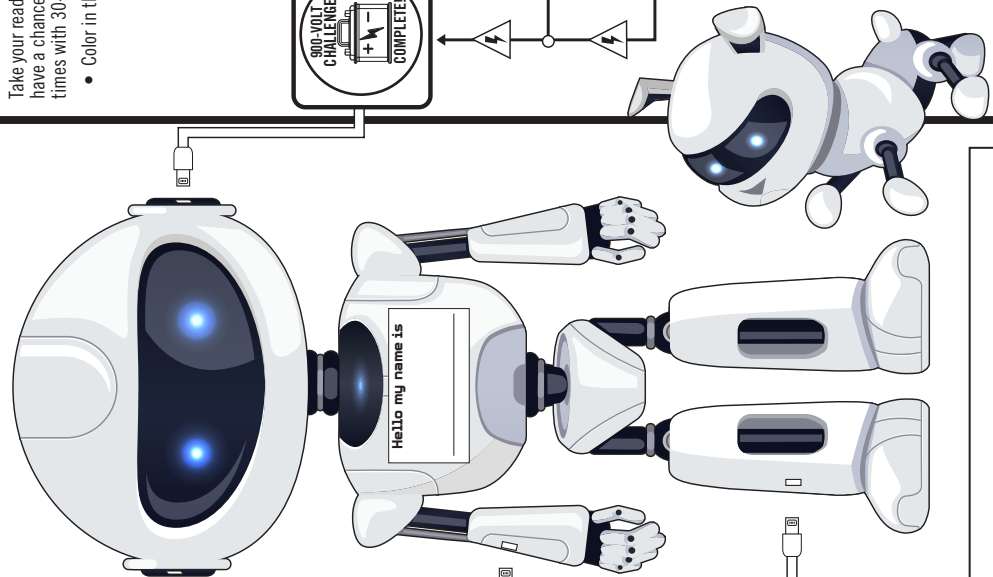

# SUPER READERS! SUPERCHARGE YOUR ROBOT

## 900-VOLT CHALLENGE

Take your reading to the next step with the 900-Volt Challenge! You'll have a chance to win even more prizes by supercharging your robot 30 times with 30-minute reading volts.

- Color in the shapes  = 30 minutes of reading

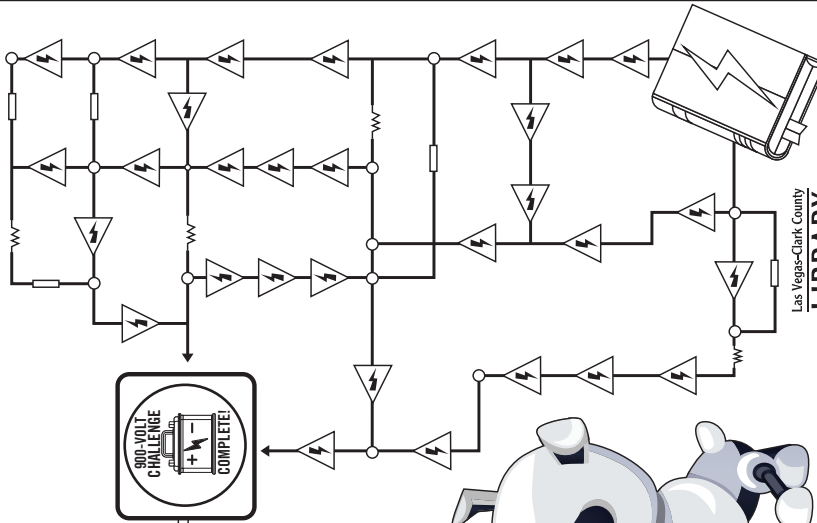

Las Vegas-Clark County  
**LIBRARY  
DISTRICT**  
LVCLD.org

Name \_\_\_\_\_ Age \_\_\_\_\_ Grade \_\_\_\_\_ Email \_\_\_\_\_

Phone Number \_\_\_\_\_ Your School \_\_\_\_\_ Your Library \_\_\_\_\_